

# Fly-back transformer design instructions

Design tool

## 1. Overview

This material describes how to design the transformer for Fly-back type power supply. It describes the using method of the Excel file provided as a transformer design tool.

## 2. Basic circuit diagram of Fly-back

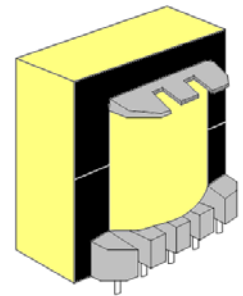
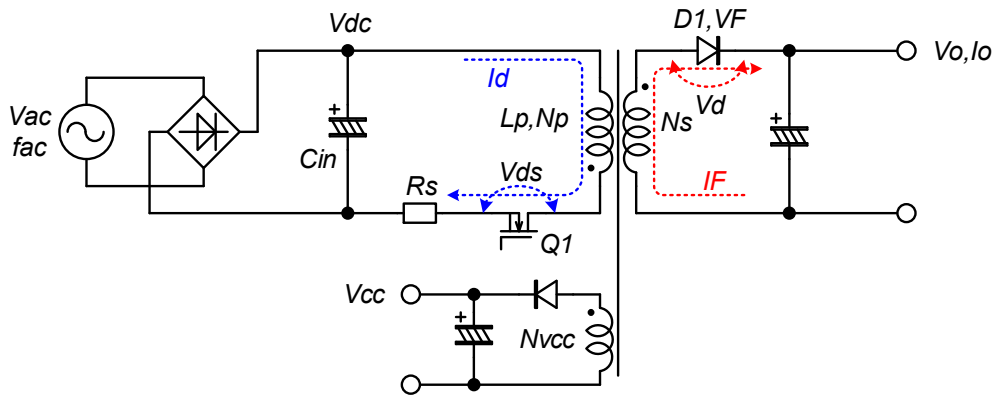

## 3. Operation modes of Fly-back circuit

Operation modes of Fly-back circuit include the discontinuous current, critical current and continuous current modes.

These operation modes vary depending on the status of input voltage and output current. (Normally, the operation modes co-exist.)

When designing the transformer, it is necessary to determine in advance which of the mode and I/O condition it should be operated on.

**Power vs. Input voltage**

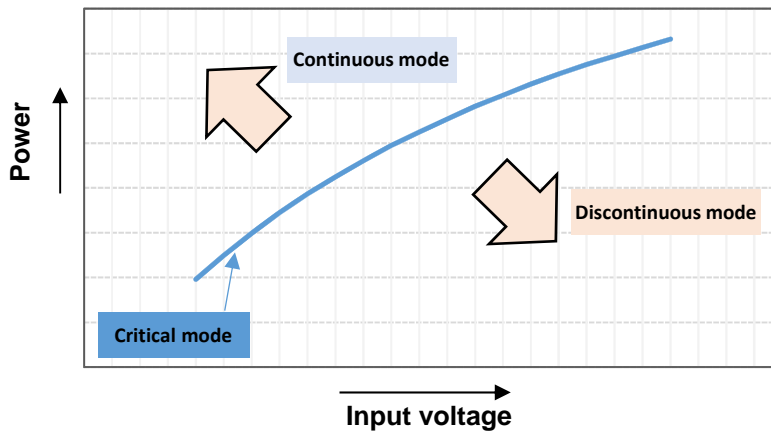

**Operation waveforms**

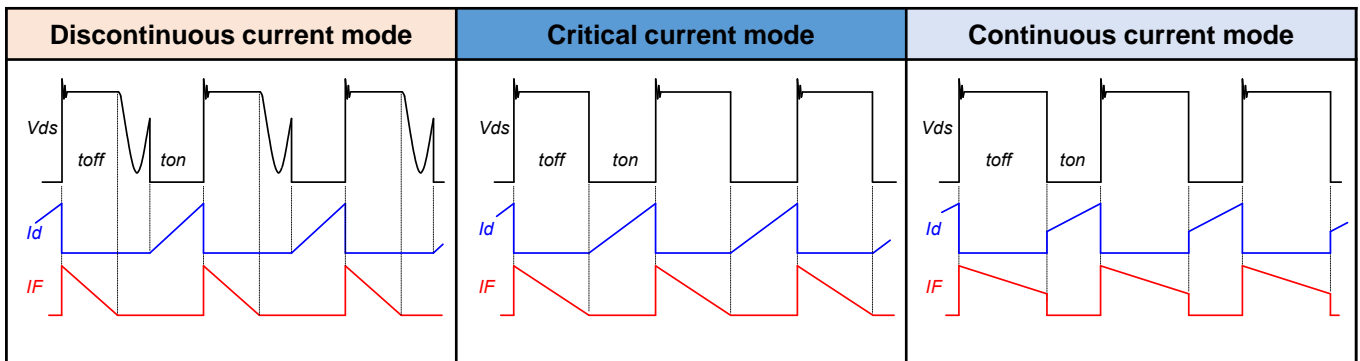

**4. Parameters required to design transformer**

Item		Symbol	Unit	Required condition
Power supply specification	Output voltage	$V_o$	Vdc	
	Rated output current (max.)	$I_o$	Adc	
	Overload protection operating current	$I_{olp}$	Adc	
	Input voltage	$V_{ac}$	Vac	Min,Max
	Input frequency	$f_{ac}$	Hz	Min
	Conversion efficiency	$\eta$	%	
	Switching frequency	$f_{sw}$	kHz	
Using part	Input capacitance of the electrolytic capacitor	$C_{in}$	$\mu F$	
	Secondary side diode VF	VF	Vdc	
	Used maximum magnetic flux density	$\Delta B$	T	
Using core	Effective magnetic path length of core	$l_e$	$mm^2$	
	Effective cross-section area of core	$A_e$	Mm	
	Relative permeability (amplitude permeability)	$\mu_a$		
Usage condition	Fly-back voltage	$V_r$	Vdc	
	MOSFET surge voltage (estimate)	$V_{sgm}$	Vdc	
	Diode surge voltage at secondary side (estimate)	$V_{sgd}$	Vdc	
	Input voltage when setting operation mode	$V_{in(cr)}$ , $V_{in(cc)}$	Adc	
	Output current when setting operation mode	$I_{o(cr)}$ , $I_{o(cc)}$	Adc	
	Continuity level when setting operation mode (For continuous mode only)	k		

**5. Parameters to be calculated**

Item		Symbol	Unit	
Calculating parameters	Output power	$P_o$	W	$P_o, P_{olp}$
	Ripple voltage (estimate)	$V_{ripple}$	Vdc	$V_{ripple}, V_{ripple(olp)}$
	Minimum input voltage	$V_{dc(min)}$	Vdc	$V_{dc(min)}, V_{dc(olp)min}$
	Maximum input voltage	$V_{dc(max)}$	Vdc	
	Input current	$P_{in}$	W	$P_{in}, P_{inolp}$
	Switching cycle	T	$\mu s$	T, $T_{on}$
	Maximum MOSFET voltage	$V_{ds(max)}$	Vdc	
	Maximum diode voltage at secondary side	$V_d(max)$	Vdc	
	Duty	D		
	Primary side inductance	$L_p$	$\mu H$	
	Number of turns at primary side	$N_p$	Tn	
	Number of turns at secondary side	$N_s$	Tn	
	Number of turns of VCC	$N_{vcc}$	Tn	
	Core gap length	$l_g$	mm	
	Peak current at primary side	$I_{peak}$	A	
	Current at primary side (effective value)	$I_{prms}$	Arms	
	Current at secondary side (effective value)	$I_{srms}$	Arms	
	Output capacitor current (effective value)	$I_{crms}$	Arms	
	Magnetic flux density in core	$B_c$	T	

**Fly-back transformer Design**
**6. Design flow of transformer for Fly-back**

Step	Item	Description
Step-0	Determine operation mode	Determine whether the critical mode (discontinuous mode) or continuous mode should be used for the design.
Step-1	Determine parameters	Temporarily determine the power supply specification and using parts.
Step-2	Determine Fly-back voltage	Determine the Fly-back voltage based on breakdown voltages of the MOSFET to be used and diode at the secondary side.
Step-3	Determine turns ratio	The turns ratio is determined based on the Fly-back voltage.
Step-4	Operation condition under critical or continuous mode	Determine each condition at the design points.
Step-5	Calculate Duty and $L_p$	Calculate Duty and $L_p$ under the operation condition of Step-4.
Step-6	Calculate $D(\max)$ on OLP	Obtain the maximum Duty for the power supply specification.
Step-7	Calculate $I_{peak}$	Obtain the maximum current $I_{peak}$ flowing through the primary side with $L_p$ set in Step-4 under the maximum Duty condition.
Step-8	Determine number of turns at secondary side ( $N_s$ )	Calculate the number of turns at the secondary side ( $N_s$ ) based on the specification of core to be used, $L_p$ and $I_{peak}$ .
Step-9	Determine number of turns at primary side ( $N_p$ )	Calculate the number of turns at the primary side ( $N_p$ ) based on the number of turns at the secondary side and turns ratio.
Step-10	Determine number of turns for VCC ( $N_{vcc}$ )	Calculate the number of turns for VCC ( $N_{vcc}$ ) based on the voltage of VCC to be used and number of turns at the secondary side.
Step-11	Determine Gap	Calculate the air-gap in the transformer to satisfy the $L_p$ value.
Step-12	Check calculation result	Check the calculation results. Here, check that the maximum magnetic flux density and the Fly-back voltage are consistent with the respective target values.
Step-13	Calculate current (at rated output)	Calculate the current value at each part under the continuous-operation condition (when checking a heat generation, for example). Here, check the calculated current values and numbers of turns at the primary and secondary sides. And if it is expected not to be turned with the estimated core (bobbin), select a core again.
Step-14	Check operation status	Check Duty, continuity level, peak current, etc. under any operation condition.

## Fly-back transformer Design

### 7. Design of transformer for Fly-back

#### Step-0 : Determine operation mode

- ◆ Determine an operation mode.
  - ✓ If you want to operate it in continuous current mode under a desired condition, select the "Continuous current mode" sheet.
  - ✓ If you want to operate it in discontinuous or critical current mode under a desired condition, select the "Critical current mode" sheet.
- ◆ Temporarily determine a core material to be used.
  - ✓ Select the core to be used by using the output power described in the catalog as a guide.

#### Step-1 : Determine parameters

- ◆ Input a power supply specification.
  - ✓ Input a power-supply I/O specification. Input the efficiency using estimate.
  - ✓ The minimum input voltage varies depending on the output power and input capacitance of the electrolytic capacitor. In this sheet, the estimates are automatically calculated.
- ◆ Input the conditions for parts to be used.
  - ✓ For the electrolytic capacitors, which have its own temperature characteristics and deteriorate over time, input the input capacitance considering those factors.
  - ✓ The used maximum magnetic flux density, varying depending on the using core material, is generally between 0.25 and 0.3T.

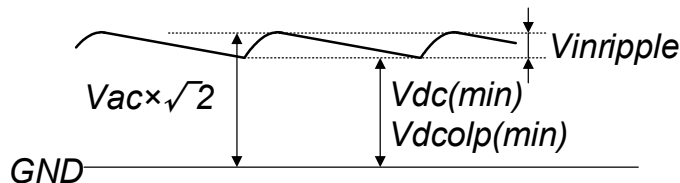

#### Step-2 : Determine Fly-back voltage

- ◆ Determine a rough standard of the Fly-back voltage.
  - ✓ Determine the Fly-back voltage ( $V_r$ ), checking the balance between the breakdown voltage of MOSFET to be used and diode voltage at the secondary side.
  - ✓ Input an estimate (about 30 V) since the surge voltages ( $V_{sgm}$ ,  $V_{sgd}$ ) are not clear at the design phase.
  - ✓ Generally, for wide power supply (90 to 264 ACV), use 600 to 900 V for the breakdown voltage. If using an item with a breakdown voltage of 600 V, consider a margin and set the Fly-back voltage to 80- to 110 V.

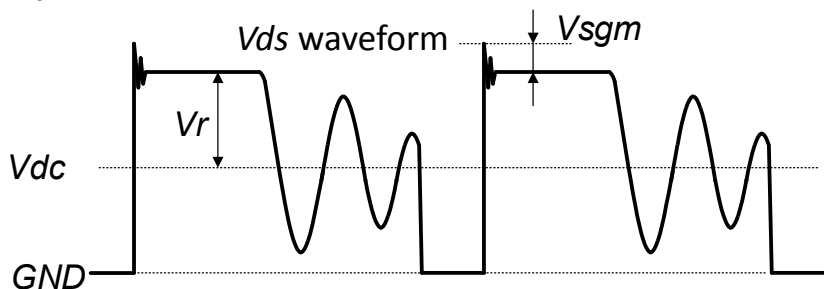

$$V_{ds(max)} = V_r + V_{dc(max)} + V_{sgm}$$

$$V_d(max) = V_o + \frac{V_o + V_F}{V_r} \times V_{dc(max)} + V_{sgd}$$

#### Step-3 : Determine turns ratio

- ◆ The turns ratio  $n$  is determined when the Fly-back voltage is determined.

$$n = \frac{N_p}{N_s} = \frac{V_r}{V_o + V_F}$$

**Step-4 : Operation condition under critical or continuous mode**

- ◆ Set under what condition the transformer is to be operated on the critical or continuous mode.
  - ✓ If the critical mode is selected, input the input voltage and output current where you want it to operate in the mode. Note that for this input voltage, the input ripple voltage is not considered.
  - ✓ If it is operated in the discontinuous mode, set the voltage and current not to reach the critical mode under the minimum input-voltage and maximum output-current conditions.
  - ✓ If designing it in the continuous mode, input the input voltage, output current and continuity level  $k$  at the design point.

$$k = \frac{I_{peak1}}{I_{peak}}$$

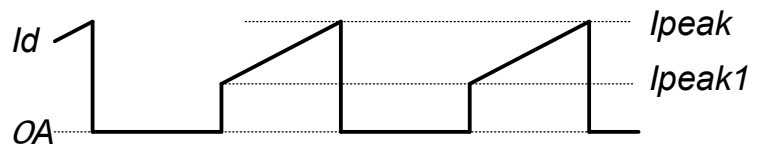
**Step-5 : Calculate Duty and Lp**

- ◆ Obtain the primary side inductance ( $L_p$ ) to operate it under the condition set in Step-4.
  - ✓ Input an estimate for  $L_p$  from the calculation result.

$$Duty = \frac{V_r}{V_{dc} + V_r}$$

$$Ton = \frac{Duty}{f_{sw}}$$

• For critical mode

$$L_p = \frac{V_{indc}^2 \times Ton^2 \times f_{sw}}{2 \times Pin}$$

• For continuous mode

$$L_p = \frac{1+k}{1-k} \times \frac{V_{dc}^2 \times Ton^2 \times f_{sw}}{2 \times Pin}$$

**Step-6 : Calculate D(max)**

- ◆ Calculate the maximum Duty during operation.
  - ✓ The operation condition for the maximum Duty is the maximum output (overload protection operating current) and minimum input voltage.
  - ✓ The operation mode for the maximum Duty is the continuous here.

$$D(max) = \frac{V_r}{V_{dcolp(min)} + V_r}$$

$$Ton(max) = \frac{D(max)}{f_{sw}}$$

**Step-7 : Calculate Ip(peak)**

- ◆ Calculate the maximum current flowing through the primary side.

$$k(max) = \frac{2L_p \times Pin_{olp} - V_{dcolp(min)}^2 \times Ton(max)^2 \times f_{sw}}{2L_p \times Pin_{olp} + V_{dcolp(min)}^2 \times Ton(max)^2 \times f_{sw}}$$

$$I_{p(peak)} = \frac{V_{dcolp(min)} \times Ton(max)}{(1 - k(max)) \times L_p}$$

**Step-8: Determine number of turns at secondary side (Ns)**

- ◆ Calculate the number of turns at the secondary side.
- ✓ Input the calculation result, rounding it up to the next whole number.

$$N_s = \frac{L_p \times I_{peak}}{n \times B_m \times A_e}$$

**Step-9: Determine number of turns at primary side (Ns)**

- ◆ Calculate the number of turns at the primary side.
- ✓ Input the calculation result, rounding it up to the next whole number.

$$N_p = n \times N_s$$

**Step-10: Determine number of turns for VCC voltage (Nvcc)**

- ◆ Calculate the number of turns for the VCC voltage.
- ✓ Input the Vcc voltage according to the operation voltage of IC to be used.
- ✓ The voltage of the VCC voltage coil wavers depending on the conditions of input voltage and output current. Thus, the number of turns for the VCC voltage calculated here is a rough guide. The number of turns should eventually be determined by actually operating it.

$$N_{VCC} = \frac{V_{CC}}{V_o + VF} \times N_s$$

**Step-11: Determine gap**

- ◆ Obtain the air-gap required for core materials to be used.
- ✓ The gap calculated here is a rough guide. Generally, manufacture the transformer by giving priority to the L value.

$$gap = \frac{\mu_0 \times N_p^2 \times A_e}{L_p} - \frac{l_e}{\mu_c}$$

**Step-12: Check calculation result**

- ◆ Check the calculation result because the L value and number of turns were set to arbitrary values.
- ✓ Ensure that the used maximum magnetic flux density does not exceed the magnetic flux density input in the Parameter.
- ✓ Ensure that the Fly-back voltage is not much of a difference than the set value.

$$B = \frac{\mu_0 \times N_p \times I_p}{\frac{l_e}{\mu_c} + gap}$$

$$V_r = \frac{N_p}{N_s} \times (V_o + VF)$$

**Step-13: Calculate current (at rated output)**

- ◆ Obtain the current value at the rated output or at the maximum output.
  - ✓ Obtain the currents at the primary and secondary sides for a rough guide of coil material to be used for the transformer.
  - ✓ Obtain the current (effective value) flowing through the output capacitor to select the electrolytic capacitor.

$$D = \frac{V_r}{V_r + V_{dc}(\min)}$$

$$T_{on} = \frac{D}{f_{sw}}$$

• For continuous mode

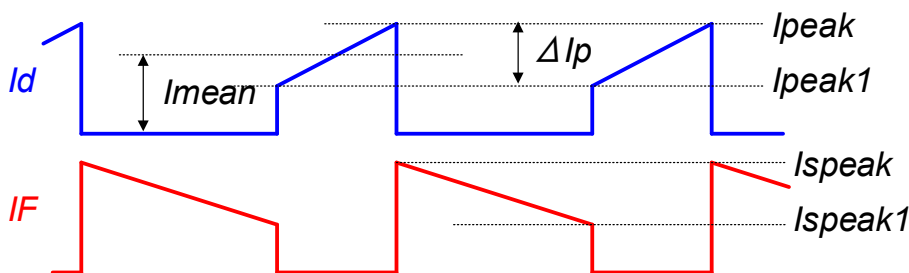

• For continuous mode

$$I_{mean} = \frac{P_{in}}{V_{dc} \times D}$$

$$\Delta I_p = \frac{V_{dc} \times D}{L_p \times f}$$

$$I_{peak} = I_{mean} + \frac{\Delta I_p}{2}$$

$$I_{peak1} = I_{mean} - \frac{\Delta I_p}{2}$$

$$I_{prsm} = \sqrt{D \times \left( \frac{\Delta I_p^2}{3} + I_p \times I_{pb} \right)}$$

$$I_{srms} = \sqrt{(1-D) \times \left( \frac{\Delta I_{sp}^2}{3} + I_{sp} \times I_{sb} \right)}$$

$$I_{crms} = \sqrt{I_{srms}^2 - I_o^2}$$

**Step-14: Check operation status**

- ◆ Check the operation status at any desired point.
  - ✓ Input an input voltage and output current, whose operation status you want to check, and the waveforms are displayed. Note that for this input voltage, the input ripple voltage is not considered.
  - ✓ Also note that this operation check is not suited for ICs equipped with the frequency reduction function.

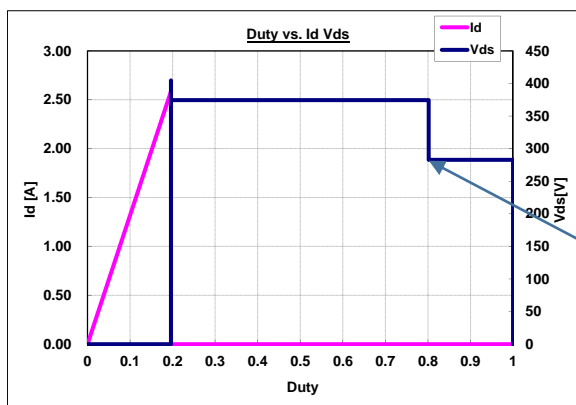

If the Vds waveform has a step, the mode becomes Discontinuous.

## Note

1. The contents of this note (Product Specification, Characteristics, Data, Materials, and Structure etc.) were prepared in July 2016. The contents will subject to change without notice due to product specification change or some other reasons. In case of using the products stated in this document, the latest product specification shall be provided and the data shall be checked.
2. The calculation results that you obtain via the method described in this material should be used only as an indication.  
The calculation results (values) obtained using this material do not assure the Fuji Electric products and its operations.
3. When reprinting or copying all or a part of this note, our company's acceptance in writing shall be obtained.

- The contents will subject to change without notice due to product specification change etc.
- Application examples and component in this sheet is for the purpose of assisting in the design. Therefore, This sheet has not been made in consideration of the margin.
- Before using, Please design in consideration of the parts variation and use condition.