

# Electric Distribution, Switching and Control Devices: Current Status and Future Outlook

ASAKAWA, Koji \*

## 1. Introduction

The Basic Energy Plan approved by Japan's cabinet in April 2014, on the premise of safety assurance and prioritizing the stable supply of energy, aims to improve economic efficiency to realize the low-cost supply of energy, to implement utmost efforts to realize environmental compliance, and to construct multi-layered, diverse and flexible energy supply-demand structures<sup>(1)</sup>.

Fuji Electric's electric distribution, switching and control devices, as key components in electrical equipment, provide the underpinning support for environmentally-friendly energy equipment, and the technical development and product development that reflects these trends is expected to contribute to society.

In addition, Fuji Electric has been selling magnetic starters<sup>\*1</sup> for the past 60 years, and our magnetic starters have continued to lead the industry as products that best meet the needs of the market and customers throughout each era, and our magnetic starter production volume reached 300 million units in 2014.

This paper looks back on the history and technical changes in magnetic starter products, and also discusses the current status and future outlook for electric distribution, switching and control devices.

## 2. Fuji Electric's Evolving Magnetic Starter Series

The changes in Fuji Electric's magnetic starter series over the past 60 years are shown in Fig. 1.

\* Technology & Manufacturing Group, Fuji Electric FA Components & Systems Co., Ltd.

Fuji Electric has continued to lead the industry through significant research and development and applying the resultant technology to our products. To date, Fuji Electric has held 556 registered patents in Japan and overseas for magnetic starters, and currently holds the rights to 196 patents, and is in the top class in Japan in this field.

In terms of technology, we have conducted research and development into the mechanical and electrical endurance performance and the connection reliability of contacts, particularly for leading-edge high-efficiency electromagnets. In this regard, we have worked to miniaturize and to lower the power consumption of devices while furthering globalization and improving the length of service life and reliability. In a comparison of current products with those from 1954, for medium-capacity class (220 V, 37 kW) devices, the device volume has been reduced to 2/5, the apparent power at the time of turn-on has been reduced to 1/4, and the maintained apparent power has been reduced to 1/12.

Fuji Electric's magnetic starters have evolved by incorporating technical advances while meeting the market needs shown in Fig. 1. These changes are described below.

In 1954, Fuji Electric developed a miniature magnetic starter that was revolutionary at the time. Using molded insulating material in the main structure and moving parts, this was the original form of the current magnetic starter.

Around 1960, the industry demanded improved productivity, factory machinery was moving toward automation, and the foremost need was for longer service life. Fuji Electric's "SRC Series," which was released in 1965, is called the "long-life" "S Series" and realized significantly improved performance as a result of developments in arc<sup>\*2</sup> technology and

### \*1: Magnetic Starter

Commonly used in electric motor circuits, magnetic starters are devices capable of circuit switching and electric motor overload protection, and are equipped with magnetic starters and overcurrent relays.

### \*2: Arc

Arcing is a type of dielectric breakdown (discharge) that occurs between electrodes as a result of a potential difference created between the electrodes. When gas molecules located between negative and positive electrodes undergo electrolytic dissociation,

ionization occurs, creating plasma through which a current flows. As a result, a current flows through what would ordinarily be a non-conductive gas. In this indeterminate space, the gas enters into an excited state, and is accompanied by high temperature and sparking.



Item	1954 (year)	1965	1978	1984	1988	1999	2011
Market needs	Long life		Miniaturization Higher performance	High reliability Digitalization	International standards Flexibility	Globalization Safety	Microminiaturization Energy savings
Product	RC Series 	SRC Series 	SC Series 	NEW SC Series 	New SC Series SGOG Series 	NEO SC Series SC E Series 	SK Series 
Features	<ul style="list-style-type: none"> <li>○ Mechanical service life 5 M cycles =&gt; 10 M cycles</li> <li>○ Electrical service life 500 k cycles =&gt; 1 M cycles</li> </ul>		<ul style="list-style-type: none"> <li>○ 63% smaller size (volume ratio)</li> <li>○ Higher voltage of 600 V AC</li> </ul>	<ul style="list-style-type: none"> <li>○ Stable contact</li> <li>○ Lower noise</li> <li>○ Lower power consumption</li> </ul>	<ul style="list-style-type: none"> <li>○ International standards</li> <li>○ Diverse product lineup</li> </ul>	<ul style="list-style-type: none"> <li>○ Standard acquisition of overseas standards</li> <li>○ Coordination with protection devices</li> <li>○ Use of environmentally friendly materials</li> </ul>	<ul style="list-style-type: none"> <li>○ Low power consumption with world's smallest size</li> <li>○ Improved utility</li> </ul>
Technology	<ul style="list-style-type: none"> <li>○ Established basic structure of electromagnet and breaker</li> <li>○ Developed contact materials and insulating material that support longer service lives</li> </ul>		<ul style="list-style-type: none"> <li>○ Developed UI magnet double-coil type miniature electromagnet</li> </ul>	<ul style="list-style-type: none"> <li>○ Developed electromagnetic super magnet that is installed in electronic circuitry</li> </ul>	<ul style="list-style-type: none"> <li>○ Modularization</li> <li>○ Development of DC electromagnet with attached permanent magnet</li> </ul>	<ul style="list-style-type: none"> <li>○ Improved efficiency electromagnetic efficiency</li> <li>○ Reduced contact bounce</li> </ul>	<ul style="list-style-type: none"> <li>○ Developed high-efficiency DC electromagnet</li> <li>○ Developed miniature switching technology</li> </ul>

Fig. 1 History of magnetic starter series

contact material and insulation material having superior properties, and its electrical service life was extended, to become 500,000 to 1 million times that of the conventional series.

For the “SC Series” that was released in 1978, in response to the need for miniaturization, Fuji Electric developed a UI magnet double coil method that combined a U-shaped fixed core and an I-shaped moving core, and applied magnetic technology to drive the switching contact part directly in medium and large-capacity models.

Around 1980, it became desired for machinery and equipment to be operated for longer durations of time, at higher capacity utilization, and with improved reliability, and magnetic starters were required to provide improved reliability and maintenance-free operation. For the “NEW SC Series” that was released in 1984, Fuji Electric developed a super magnet, an electromagnetic drive system that is integrated with the electronic circuitry. Without any contact bouncing even when voltage fluctuations are large, this series solves a problem relating to electromagnets and contacts, and achieves lower power consumption. Additionally, control has been moved from a relay sequence to a programmable logic controller (PLC) and in response to the need for low-level voltage and current, Fuji Electric has developed an auxiliary contact material and shape to ensure the contact reliability of auxiliary contacts.

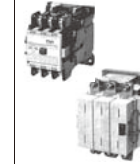
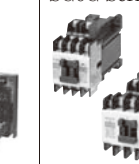
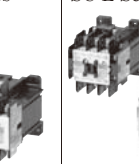
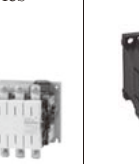
Around 1990, as magnetic starters became more popular and their applications increased, the requested specifications and functions became more

diverse, and flexible support with a wide variety of products and functions was required. Additionally, there have been remarkable advances in the high-level automation of production systems such as factory automation (FA) and flexible manufacturing systems (FMS). Previously, with the “New SC Series” that was released in 1988, so that the main structure would be suitable for the flexible production of magnetic starters, the electromagnet part, contact part and coil part of the main body were modularized, and modules and components were shared commonly among the various models. The functionality and variety of accessories, such as an auxiliary contact unit, were enhanced, and the accessories were designed as customer-detachable structures that are common among an entire series. As control systems became electronic, improved contact reliability was required and so a dual contact structure was adopted as a standard feature for auxiliary contacts. The color of the cover was changed from solid black to a cream color and the design was updated with an arrangement of orange lines, and this design has continued as Fuji Electric’s magnetic starter design.

Around 2000, with EU integration, JIS internationalization and the like, the market continued to advance toward becoming borderless, and a response to safety and environmental issues was sought. Fuji Electric realized a response to these issues with the “Neo SC Series” that was released in 1999. At that time, the evolution and widespread use of PCs enabled advanced analysis techniques for transient phenomena, and through simulations

of bounce coupled to analyses of the electromagnetic field, mechanism, and vibration, contact bounce was reduced, the efficiency of AC and DC electromagnets was improved, and miniaturization and reduced power consumption were achieved.

The “SK12 Series” of mini-contactors<sup>\*3</sup> and thermal relays<sup>\*4</sup> that was released in 2011 has the world’s smallest micro-miniature size, and satisfies both domestic and overseas specifications and standards, while realizing lower power consumption, and a high-level of safety, utility, and ease of use.

### 3. Market Trends and Fuji Electric’s Efforts<sup>(2)</sup>

In the electric distribution, switching and control device sector, while improving the level of current switching, breaking, detection and measurement technologies in response to market needs, Fuji Electric is also advancing the development of new technologies and incorporating those technologies into products for the global market and emerging markets. Figure 2 shows an overview of the present status and future efforts, and Fig. 3 shows the market and technological trends.

#### 3.1 Machine control panel

Recent market needs in the machine control panel sector include compatibility with changes in motor control systems, and compatibility with IE3 motors that are used for energy savings, and inverters and servos.

(a) Changes in motor control systems as a result of globalization<sup>(3)</sup>

As globalization progresses, the alignment of each country’s individual standards with IEC standards is a trend not only in Japan but is common throughout the world, and as a result, electric motor control systems are changing. As shown in scheme A of Fig. 4, the mainstream electric motor control method used in Japan is one in which over-current protection devices<sup>\*5</sup> are not installed in the branch circuits. According to indoor wiring regulations<sup>\*6</sup>, a dedicated branch circuit must be provided for each electric motor unit, but with a 20 A molded-case circuit-breaker (MCCB)<sup>\*7</sup>, if the total electric motor capacity is 2.2 kW, individual over-current protection devices will be unnecessary. Meanwhile, overseas, scheme B and scheme C that provide an over-

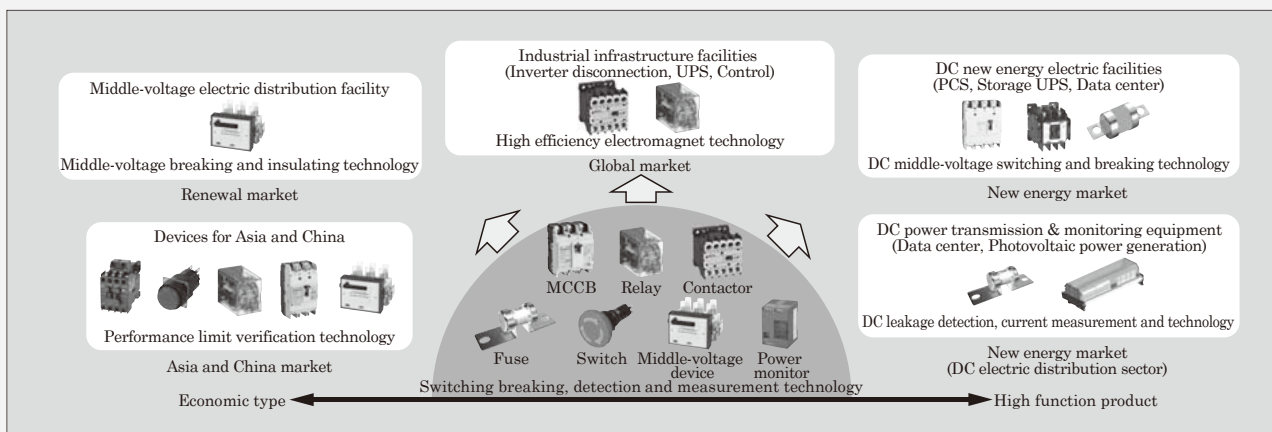

Fig. 2 Efforts for electric distribution, switching and control devices

#### \*3: Magnetic contactor

An magnetic contactor is a device that is operated directly with an electromagnet, and is characterized as being able to switch overcurrent and to switch electric circuits frequently. The magnetic contactor is also known as a contactor.

#### \*4: Over-current relay (thermal relay)

An over-current relay is a device that detects overload currents and is typically used to prevent motor burnout. Used in combination with an magnetic contactor, an over-current relay is also referred to as a thermal relay.

#### \*5: Over-current protection device

An over-current protection device breaks and protects an electric circuit in the case where an overload or short-circuit current flows, and this device refers to molded-case circuit-breakers and manual motor starters.

#### \*6: Indoor wiring regulations

Indoor wiring regulations are a commercial standard for the design, construction, maintenance and management of electrical structures at the site of demand. These regulations are intended to be supplements that further interpret the various laws and technical standards for electrical installations. Power companies use these

regulations as a reference when inspecting and examining electrical construction work, and they are applied to general electrical structures and residential-use electrical structures (excluding special middle-voltage equipment).

#### \*7: Molded-case circuit-breaker (MCCB)

Molded-case circuit-breakers are devices that have the capability to perform current switching at or below the rated current value in a low-voltage circuit, to detect overcurrents, to break large currents such as short-circuit current, and are mainly used to protect wiring. A molded-case circuit-breaker is also referred to as a MCCB.

Item		2005 (year)	2010	2015
Market needs	Trend	Globalization, expansion of new emerging markets		
		Energy savings		
		New energy		
	Regulations and standards	○ Environmental regulations (REACH regulations)	○ Environmental regulations (POPSs treaty)	○ Top runner program (Transformers, IE3 motors)
Product technology	○ 2-contact opening mechanism	○ Ultra mini mechanical technology	○ High efficiency electromagnet technology ○ Performance limit verification technology ○ Middle-voltage breaking technology	
Basic technology		○ Arc gas flow control and breaking technology	○ DC middle-voltage breaking technology ○ DC electric distribution system protection technology ○ Arc simulation technology	
New products of electric distribution, switching and control devices	○ Manual motor starter	○ G-TWIN Series ○ 16minico Series	○ FJ Series ○ SK Series ○ G-TWIN A Series, DC middle-voltage circuit breaker ○ Emergency stop pushbutton switch (φ 22, φ 30) ○ MULTI.VCB ○ LBS ○ F-MPC04E ○ String monitoring unit	

Fig.3 Trends of electric distribution, switching and control devices

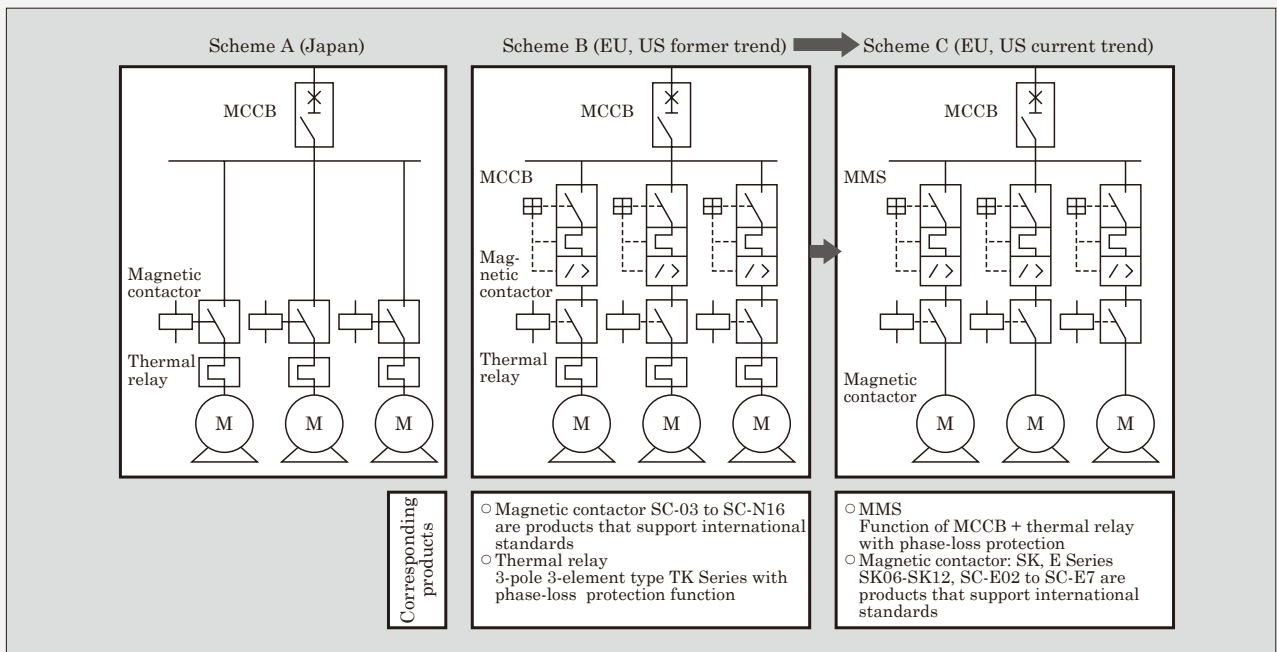

Fig.4 Change in electric motor control methods

current protection device for each electric motor circuit are required. Recently, in consideration of control panel safety, further expansion of the short-circuit current rating (SCCR) is requested, and in order to attain breaking coordination with an magnetic contactor, protection devices that have a high current-limiting capability during short-circuit current breaking are required.

With such an electric motor protection circuit, the application of a manual motor starter (MMS)

or a combination starter results in an electric motor control system that is highly efficiency and that realizes “space savings,” “wire savings” and “high-level short-circuit protection coordination.” An MMS is an integrated MCCB and thermal relay, and a combination starter is an MMS further combined with an magnetic contactor. Combining electromagnetic contact technology developed over many years with the switching and breaking technology of MCCBs, the MMS employs a dual-

contact breaking (double break) mechanism, and has the features of excellent contact wear during contact switching and excellent current limiting and cut-off performance. In 2002, Fuji Electric commercialized Japan's first MMS and combination starter. Additionally, Fuji Electric also plans to provide a lineup of combination starters that incorporate the "SK Series," which are introduced in this special issue.

(b) Support of top runner motors (IE3 motors)

In Japan, industrial motors will be added to the top runner program\*8 as of April 2015. Industrial motors have been estimated to account for 75% of the annual power consumption of the industrial sector. At present, 97% of the motors used in Japan are IE1 (standard efficiency) level motors, and if all motors were to be replaced with IE3 (premium efficiency) level motors, the energy savings effect is estimated to be 1.5% of the total power consumption in Japan, corresponding to 15.5 billion kWh/year. According to a survey by The Japan Electrical Manufacturers' Association (JEMA) of the motors of various companies, compared to IE1 motors, IE3 motors draw higher average startup current but limit the maximum value. For this reason, they do not have a significant effect on the performance of magnetic starters (magnetic contactors and thermal relays).

(c) Application to inverter and servo primary-side switching

Historically, magnetic starters have been developed for, and used in, motor switching applications. Until around 2000, the majority of applications had been in motor direct on-line applications, but as power saving and control technology advances, inverters and servos have come into widespread use, and their application in primary-side switching applications is increasing rapidly, and account for 50% of the applications at present. Figure 5 shows the findings of a survey by Fuji Electric about the changes in magnetic starter applications.

When using inverter and servo systems, at the time when a magnetic starter is switched on, due to the charging current from an internal smoothing capacitor, the inrush current may be greater than that of the starting current of a conventional motor, and therefore the contact welding resistance must be improved. Table 1 shows the results of a survey (as estimated from customer interviews) of the electrical switching endurance required of magnetic starters. Essentially, a switching endurance of 1 million

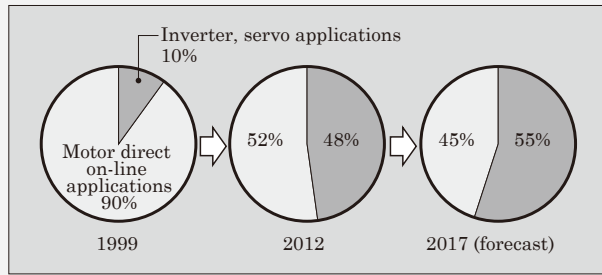

Fig.5 Changes in magnetic starter applications

Table 1 Electrical endurance required of magnetic starter for switching and circuit breaking use

Application	Max. number of switching operations per day (number of times)	Max. number of switching operations per day (number of times)	Max. number of switching operations over 10 years (tens of thousands of times)
UPS	-	1	Up to 0.365
Inverter, servo primary side	1	20	Up to 7.3
Air conditioning, compressor	3	60	Up to 21.9
Power supply switching	10	200	Up to 73
Transportation (Direct on line)	20	400	Up to 146

times will satisfy the needs of the majority of applications, and the number of switching operations in a drive device is assumed to be about 100,000 times. Under these circumstances, the "SK18" and "SK22" were developed as the optimal SK Series devices for primary-side switching applications (for low-frequency switching, current switching, and disconnection). Further details are described in section 4.1.

3.2 Electric distribution equipment

(a) Renewable energy and smart grids

With the expanded use of renewable energy such as photovoltaic power generation, the popularization of electric vehicles, and the establishment of middle-voltage DC power supply systems for data centers, smart grids, and the like, DC distribution systems that differ from conventional distribution systems are continuing to expand. The establishment of DC protection technology to ensure safe operation has become necessary, and research and development of failure modes, such as short-circuits and ground faults, is being advanced (refer to "Technology of Estimating Short Circuit Current and Ground Fault for Direct

\*8: Top runner program

Based on Japan's "Act on the Rational Use of Energy" (Energy Saving Act), for

each target device, the top runner method sets standards that are higher than those of the (top runner) device having the best ener-

gy efficiency, determines a target fiscal year, and promotes the widespread use of energy-saving products.

Current Distribution Systems” on page 179).

After the Great East Japan Earthquake that occurred in FY2011, a system of “Feed-in Tariff Scheme for renewable energy” (FIT) has been adopted, and photovoltaic power generation facilities, for which construction work can be carried out relatively easily, are increasingly being installed. Until 2011, the majority of installations were for residential use, but following the enforcement of FIT, the introduction of power-generation business facilities for non-residential use has been increasing rapidly. On the other hand, for photovoltaic cells, which had been called maintenance-free, in the ten years after installation, there is a greater than 10% incidence of photovoltaic cell panel failure due to hot spots caused by shadows on the panel surface, Potential Induced Degradation (PID) phenomena that degrades output, solder defects during production, and the like, and higher efficiency and reliability are demanded. Moreover, in order to reduce the power generation cost, the trend toward the higher voltage of 1,000 V DC is progressing.

Fuji Electric has focused its efforts on technical development that addresses this need for improved reliability and higher voltage, and has commercialized a string monitoring unit that measures and continuously monitors the generated current and voltage for each DC middle-voltage circuit breaker and string, and that is capable of breaking operation even when a reverse current is flowing. In commercializing this device, Fuji Electric researched arc simulation technology, and used its DC middle-voltage circuit breaking technology (refer to “Arc Simulation Technology” on page 195).

(b) Longer service life and renewal demand for infrastructure

Partially in response to the Sasago Tunnel ceiling collapse on the Chuo Expressway in December 2012, the Japanese Ministry of Land, Infrastructure and Transport enacted an action plan for extending the service life of infrastructure in May 2014.

With this action plan, ensuring public safety and security, total cost reduction and budget leveling for medium- and long-term maintenance and updating, and ensuring competitiveness of the maintenance industry are necessary. Furthermore, the action plan does not stop at so-called lifecycle prolongation, i.e., extending the service life from new construction through demolition, and is also linked to establishment of

a maintenance cycle and continuous development through various initiatives, including renewal, so that essential infrastructure functions will continue to be exhibited into the future.

For middle-voltage electric distribution devices, through using the latest middle-voltage circuit breaking and insulating materials and pursuing lower lifecycle cost and greater ease-of-use, Fuji Electric is working to develop new products from which the customer will derive an immediate benefit at the time of renewal. In recent years, Fuji Electric has developed the “MULTI.VCB,” “Auto.V” and middle-voltage AC load break switches (LBS) equipped with striker tripping-type current-limiting power fuses. Further details are described in section 4.4.

### 3.3 Overseas markets

For Asian markets, there is brisk investment in infrastructure despite the risks; Japanese companies are expected to continue to make investments, and products that meet market needs (specifications and price) are needed. For this region, Fuji Electric is working to expand its lineup of switches, such as magnetic starters, and low-voltage electric distribution devices, such as circuit breakers for wiring. High-frequency switching operations are not required for air-conditioning equipment and the like, and so Fuji Electric has released the “FJ Series” of low-cost and durable magnetic starters for the Asian and Chinese markets. Fuji Electric’s product lineup, which had previously been compatible with currents of up to 32 A, has been expanded to handle currents of 40 to 95 A.

Additionally, centered around Fuji Tusco in Thailand, Fuji Electric is prioritizing the expansion of its Asian business for substation equipment. Middle-voltage electric distribution devices used in middle-voltage electric distribution panels are required to be 7.2 kV JIS-compliant for use in Japan, but in Southeast Asia, the devices must be 24 kV IEC-compliant. For this reason, 24 kV vacuum valves, small and strongly insulated structures, interlocked structures and the like are required. In the future, Fuji Electric intends to advance its efforts for product development in this field.

## 4. Fuji Electric’s Efforts Involving the Latest Devices

### 4.1 Switching devices\*9

The “SK Series” of magnetic contactors was released in 2012 and with a rating of up to 12 A is classified as being within the miniature range, and

#### \*9: Switching device

Switching devices are used with low-

voltage circuits to switch motors and other electric circuits frequently. In this special

issue, switching devices are referred to as magnetic contactors and magnetic starters.

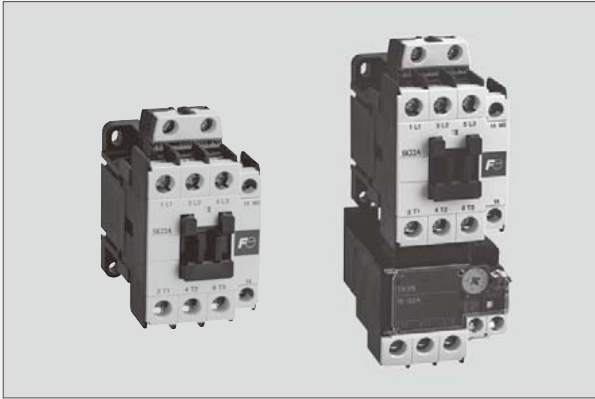

Fig.6 Magnetic contactors and starters “SK18” and “SK22”

is receiving good reviews as a magnetic contactor having the world’s smallest size and low-power consumption. Additionally, the SK Series was expanded in June 2014 with 18 A and 22 A rated models, the “SK18” and “SK22” (see Fig. 6). In this development work, we improved high-efficiency electromagnetic technology and succeeded in developing a miniature-size, low-power consumption DC electromagnet.

The SK18 and SK22 inherit the basic features of the “SK12” and are products well suited for inverter and servo primary-side switching applications (for low-frequency switching, current switching, and disconnection). Their main features are listed below.

(a) Miniaturization

A 15% reduction in width and a 13% reduction in depth, compared to conventional devices, were realized. As DC operating types, these are the world’s smallest size devices for this rating class.

(b) Lower coil power consumption

A 66% reduction in power consumption, compared to conventional devices, was realized. As DC operating types, these are the world’s smallest size devices for this rating class.

(c) Improvement of welding current limit

Improvement by a factor of 2.5 times, compared to conventional devices, was realized.

Further details are described in “Magnetic Contactor ‘FJ Series’ and ‘SK Series’ Line Expansion” on page 163.

**4.2 Control devices\*10**

A representative control device is the operating switch. An emergency stop pushbutton switch is an important operation switch used to prevent injury to humans and damage to machinery, and safety



Fig.7 Emergency stop pushbutton switch (φ22) with “Synchro Safe Contacts”

and reliability of the switch is absolutely essential. In recent years, international standards relating to safety of machinery have been codified, and based on those standards, improved product safety is sought. Through an exhaustive pursuit of reliability and safety, Fuji Electric has developed emergency stop pushbutton switches (φ22 and φ30) which are integrated with “Synchro Safe Contacts” and that support various safety solutions. In this development work, Fuji Electric improved the technology of miniature switch mechanisms that use molded parts, and has developed a mechanism whereby the NC contact must be in the open state while the trigger action or the operating element and the contact block are separated.

The appearance of the φ22 emergency stop pushbutton is shown in Fig. 7, and main features are listed below.

(a) Proprietary “Synchro Safe Contact”

(b) Side indicator that improves visibility of contact operation status

(c) Safety trigger action mechanism

(d) Easily removable operating element and contact block

Further details are described in “Emergency Stop Pushbutton Switches (φ22 and φ30) Integrating ‘Synchro Safe Contact’” on page 169.

**4.3 Low-voltage circuit breakers\*11**

In photovoltaic power generating systems for non-residential applications in Japan, in order to reduce the power generation cost, there is a trend toward higher voltages, from 600 V and 750 V to 1,000 V DC, and there is increasing demand for safety at the time of an accident. Because direct current has no current zero point, the arc voltage must be forcibly boosted to a level greater than the power

**\*10: Control device**

Control devices are used in low-voltage control circuits to control machines and systems. In this special issue, control devices are referred to as operating switches, relays,

sensors and timers.

**\*11: Low-voltage circuit breaker**

Low-voltage circuit breakers are circuit breakers used in low-voltage circuit to

protect against bodily harm, and damage to wires and devices. In this special issue, they are referred to as molded-case circuit-breakers, earth leakage breakers, and manual motor starters.

supply voltage. Moreover, it has been indicated that a reverse current flows when a short circuit exists between the connection box and the junction box, and a device that can ensure safety is required. On the basis of such market trends, Fuji Electric is researching and developing DC middle-voltage circuit breaking technology, and based on 1,000 V DC non-polar circuit breaking technology, has recently developed a reversibly connectable circuit breaker (400 to 800 AF) for DC middle-voltage circuits. The main features of this circuit breaker are listed below.

- (a) External dimensions: Same as “G-TWIN Series” 400 to 800 AF
- (b) Rated operating voltage: 750 V DC (3-pole device), 1,000 V DC (4-pole device)
- (c) Internal and external accessories: Common for all devices in the G-TWIN Series
- (d) Can be connected in reverse (no polarity)
- (e) Lineup of non-trip switches (load switches)

Further details are described in “No-Polarity Interruption Technology of Circuit Breakers for High-Voltage Direct Current” on page 174.

#### 4.4 Middle-voltage electric distribution devices\*12

Amidst advances in information technology, middle-voltage electric distribution devices are increasingly being requested to provide a stable supply of electric power and to have higher reliability. Such equipment has also been used in photovoltaic power generation facilities in recent years, and its applications are expanding. Products are sought that incorporate such market trends as miniaturization, improved ease of use, and improved environmental durability, and that also lower the lifecycle cost, including maintenance, installation and renewal.

Under these circumstances, Fuji Electric implemented a model change of its basic series of general-use high-vacuum circuit breakers and load switches that our customers have continued to use over several decades, and developed the “MULTI.VCB,” “Auto.V” and middle-voltage AC load break switches (LBS) equipped with striker tripping-type current-limiting power fuses. Figure 8 shows the appearance of a MULTI.VCB and Fig. 9 shows the appearance of a LBS.

- (1) Features of “MULTI.VCB” and “Auto.V”

- (a) Lower lifecycle cost

The lubrication cycle has been extended from 3 years to 6 years, and the device can be accessed from its front panel for servicing.

- (b) Improved environmental durability of insula-

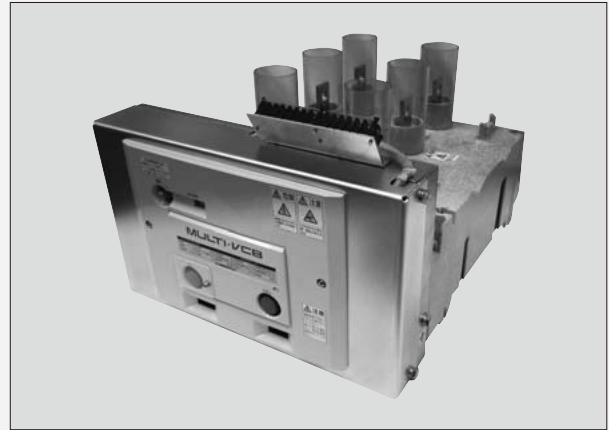

Fig.8 Middle-voltage vacuum circuit breakers “MULTI.VCB”

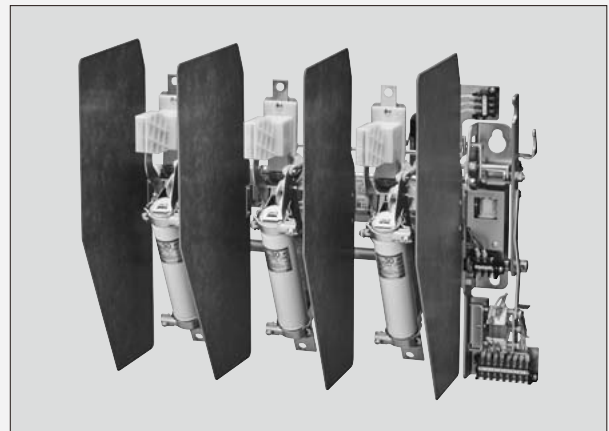

Fig.9 Middle-voltage air load break switch (LBS)

tion performance

The anti-tracking performance has been improved.

- (c) Improved ease-of-use

Panel cutting has been streamlined, and a terminal block is provided as standard equipment.

- (2) Features of the middle-voltage AC load break switches (LBS) equipped with striker tripping-type current-limiting power fuses

- (a) Miniature size (10% reduction in volume compared to conventional products)

- (b) Improved ease of use

For the task of fuse replacement, workability and safety have been improved, and a one-touch isolation barrier has been realized.

#### 4.5 Power monitoring devices

Amidst the expanding use of renewable energy, as a photovoltaic-related device that supports high

#### \*12: Middle-voltage electric distribution devices

Middle-voltage electric distribution devices are essential for middle-voltage elec-

tric distribution facilities. In this special issue, middle-voltage electric distribution devices refer to middle-voltage circuit breakers, middle-voltage load switches, middle-

voltage fuses, middle-voltage magnetic contactors, and protection relays.



DC voltage (1,000 V DC), Fuji Electric has developed a “F-MPC PV” string monitoring unit that enables the generated current and generated voltage of each string to be measured and continuously monitored. The features of this device are listed below.

- (a) Measurement of high DC voltage up to 1,000 V DC max
- (b) Measurement of up to 12 strings
- (c) Collective monitoring of temperature and digital input information necessary for monitoring interior of the connection box
- (d) High-precision measurement based on shunt resistance method
- (e) Integrated collective management with upper-level monitoring system

Market trends in this sector include miniaturization, compatibility with existing facilities, and the movement to eliminate control power supplies and communication wiring. In response to these trends, Fuji Electric is carrying out technical development of such topics as a current detection method that uses a Hall current transformer, the acquisition of control power from photovoltaic power generation, conversion to wireless technology, and the

like, and plans to improve its lineup of models.

## 5. Postscript

This paper has reflected on the historical and technological changes in magnetic starters for Fuji Electric’s electric distribution, switching and control devices, and has also described recent market trends and Fuji Electric’s related efforts.

Fuji Electric intends to continue to promote research and technical development in response to societal and market changes, and to continue to contribute to society by providing reliable products that satisfy our customers in Japan and overseas.

## References

- (1) Ministry of Economy, Trade and Industry. Strategic Energy Plan (Provisional Translation). 2014-04.
- (2) Asakawa, K. Current Status and Future Outlook for Electric Distribution and Control Devices. FUJI ELECTRIC REVIEW. 2012, vol.58, no.3, p.90-97.
- (3) Nagahiro, I. Fuji Electric’s New Global Motor Control Series. FUJI ELECTRIC REVIEW. 2006, vol.52, no.4, p.130-136.





\* All brand names and product names in this journal might be trademarks or registered trademarks of their respective companies.